

INSTALLATION MANUAL FOR ROOM AIR CONDITIONER

(Split Wall-Mounted Type)

A

- For correct installation, read this manual before starting installation and save this manual in a safe place for future reference.
- Only trained and qualified service personnel should install, repair or service air conditioning equipment. Users should not install the air conditioner by themselves.
- All pictures are only sketches. If there is any difference between pictures in this manual and the actual shape of the air conditioner you purchased, the actual shape shall prevail.

INSTALLATION PRECAUTION

Installation in the following places may cause trouble. If it is unavoidable, please, consult with the local dealer.

- A place full of machine oil.
- A saline place such as coast.
- A place full of sulfide gas such as hot-spring resort.
- Places where there are high frequency machines such as wireless equipment, welding machine, and medical facility.
- A place there is no combustive gases and volatile matter.
- A place of special environmental conditions.

Indoor Unit

- A place where is no obstacle near the inlet and outlet area.
- A place which can bear the weight of the indoor unit.
- A place which is convenient to maintenance.
- A place which provides the space around the indoor unit as required right in the diagram.
- A place 1m or more to TV, radio instrument, in the center of the room is perfect.
- A place which is far from heat, steam and inflammable gas.

Outdoor Unit

- A place, which is convenient to installation and not exposed to a strong wind. A place that is dry and ventilated.
- A place can bear the weight of the outdoor unit and where the outdoor unit can be held in the horizontal position.
- A place which does not allow an increase in noise level and vibration.
- A place where the operation noise and discharge air do not disturb your neighbor or animals.
- A place free of a leakage of combustive gases.
- An allowable head level at the connective piping is less than 5m and length of the connective piping is up less than 10m.
- No any obstacle which block radiate air.
- Unavailable to children.
- A place, which provides the space around the outdoor unit as required right in the diagram.

Parts Installation

Part No.	Name of part	Q'ty
1	Installation plate	1
2	Mounting screw ST3.9×25-C-H	8
3	Clip anchor	8
4	Refrigerant pipe	Liquid side ϕ 6.35
		Gas side <12000Btu/h> ϕ 9.53
		Gas side \geq 12000Btu/h ϕ 12.7
5	Remote controller	1
6	Seal	1
7	Drain elbow	1

Please install the accessories attached with unit correctly according to this installation manual.

Note:

1. At least two of A, B, C aspects are free from blocking.
2. When the Outdoor Unit is higher than the Indoor Units, to prevent the rain from flowing into the indoor along the connection pipe, a downward tipping arc should be made before the connection pipe entering the wall to indoor to ensure the lowest point on the connection pipe is at outdoor.
3. The illustration above is only a sketch. Different models would be slightly different.

Anchor bolts of out door unit installation

- The outdoor unit should not be exposed to strong wind.
- Fix the outdoor unit with ϕ 10 or ϕ 8 anchor bolts.

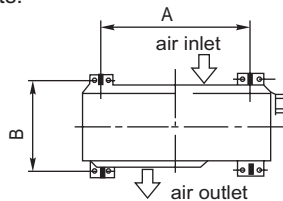

Model	A(mm)	B(mm)
<12000Btu/h	549	276
\geq 12000Btu/h	530	290

- If need suspending installation, consults the corresponding requirement.

Cautions on remote controller installation

- Before installation, operate the remote controller to determine its location in a reception range.
- Keep the remote controller at least 1m apart from the nearest TV set or stereo equipment.
- Do not install the remote controller in a place exposed to direct sunlight or close to a heating source, such as a stove.
- Note that the positive and negative poles are right positions when loading batteries.

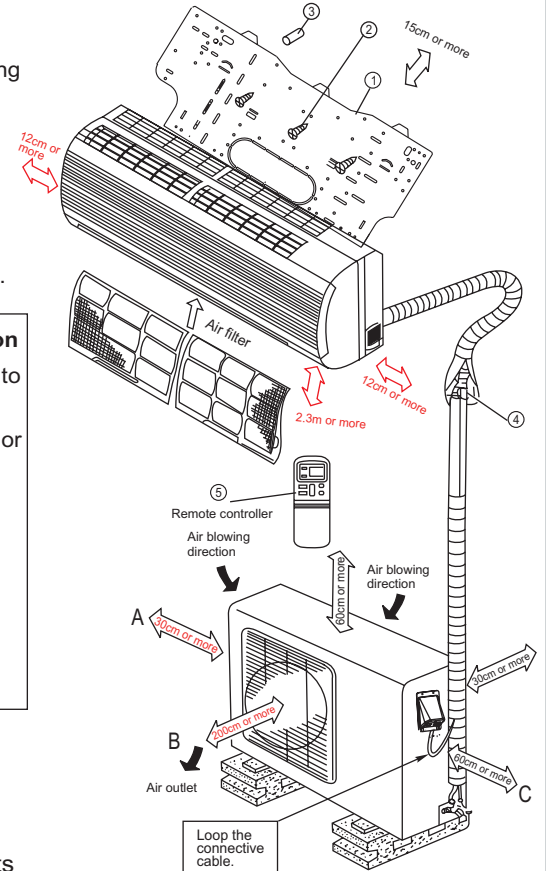

① INDOOR UNIT INSTALLATION

1. Drilling A Hole and Mounting Installation Plate

The Installation Plate would look like one of the following(Depending on models):

Installation Plate and Its Dimension (Unit: mm)

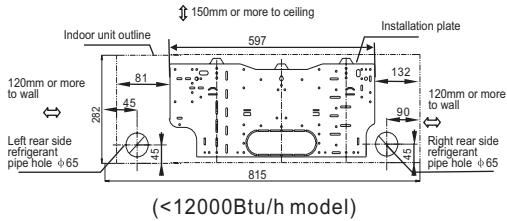

(<12000Btu/h model)

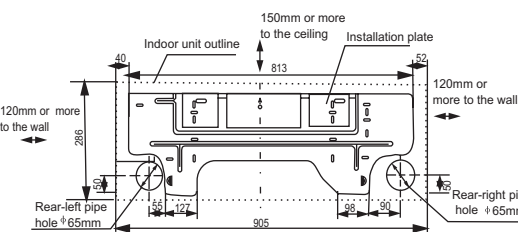

(\geq 12000Btu/h model)

1. Fix the installation plate.

1. Install the installation plate horizontally on structural parts in the wall with the spaces provided around the plate.
2. In case of brick, concrete or similar type walls, make 5mm dia holes in the wall. Insert clip anchors for appropriate mounting screws.
3. Fix the installation plate on the wall.

Installation Plate

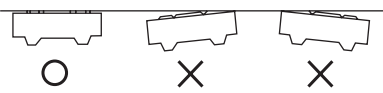

2. Drilling a hole.

1. As diagram above determine the pipe hole position using the installation plate, drill the pipe hole (ϕ 65mm), the outside pipe hole is 5~10mm lower than the inside one, so it slants slightly downward.

3. Indoor Unit Installation

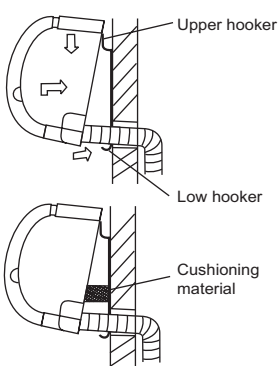

1. Pass the piping through the hole in the wall.
2. Put the upper claw at the back of the indoor unit on the upper hook of the installation plate, move the indoor unit from side to side to see that it is securely hooked.
3. Piping can easily be made by lifting the indoor unit with a cushioning material between the indoor unit and the wall. Get it out after finish piping.
4. Push the lower part of the indoor unit up on the wall, Then move the indoor unit from side to side, up and down to check if it is hooked securely.

2. Connective Pipe and Drainage Installation

1. Drainage

1. Run the drain hose sloping downward. Do not install the drain hose as illustrated below.

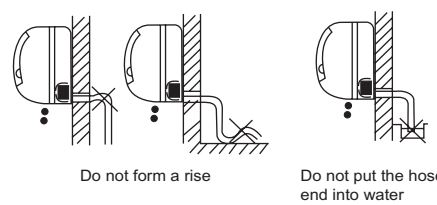

2. When connection extension drain hose, insulate the connecting part of extension drain hose with a shield pipe

3. Piping and bandaging

Wind the connective cable, drain hose and wiring with tape securely, evenly as shown below.

- Because the condensed water from rare of the indoor unit is gathered in ponding box and is piped out of room. Do not put anything else in the box.

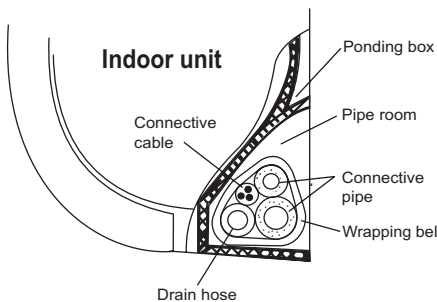

2. Connective pipe

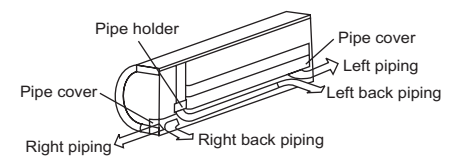

1. For the left-hand and right-hand piping, remove the pipe cover from the side panel.
 - Explain to clients that the pipe cover must be kept as it may be used when relocate the air conditioner to any other place.
2. For the left-hand and rear-left-hand piping, install the piping as shown. Bend the connective pipe to be laid at 43mm height or less from the wall.

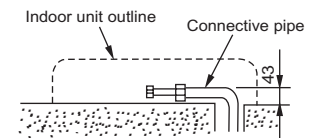

3. Fix the end of the connective pipe. (Refer to Tightening Connection in REFRIGRANT PIPING CONNECTION)

CAUTION

- Connect the indoor unit first then the outdoor unit and bend and arrange the pipe carefully.
- Do not allow the piping to let out from the back of the indoor unit.
- Be careful not to let the drain hose slack.
- Insulate both of the auxiliary piping.
- Banding the drain hose under the auxiliary pipe.
- Do not allow the power cable and control cable be crossed.

① INDOOR UNIT INSTALLATION

4. Wiring

Prepare the power source for exclusive with the air conditioner.

The supply voltage must comply with the rated voltage of the air conditioner:

Model	Power Source	Plug socket and Fuse rating	AWG(MIN.)	
			Power supply cord	Connecting cable
<12000Btu/h	60Hz 115V~	32/25A	14	18
≥12000Btu/h				

CAUTION

- Perform the wiring with sufficient capacity. Installation places legally require a short circuit isolator to be attached to prevent electrical shock.
- Do not extend the power cable code by cutting.
- Power voltage should in the range of 90%~110% of rated voltage.
- The plug of the air conditioner takes a grounding leg, so clients should use a grounding socket so that the air conditioner can be grounded efficiently.
- The cross section area of the wiring in the table is based on the copper core inside plastics.

5. Connecting Cables

1. Indoor/Outdoor connection cable should be Aw18 or more.
2. Open the panel, remove the Electrical Box cover by loosening the screw (For <12000Btu/h models). Remove the panel and Screw Covers, then loosen the screws and take down the frame (For ≥12000Btu/h models).
3. Connect cables according to their marks to terminals.
4. Wrap those cables not connected with terminals with insulation tapes, so that they will not touch any electrical components.

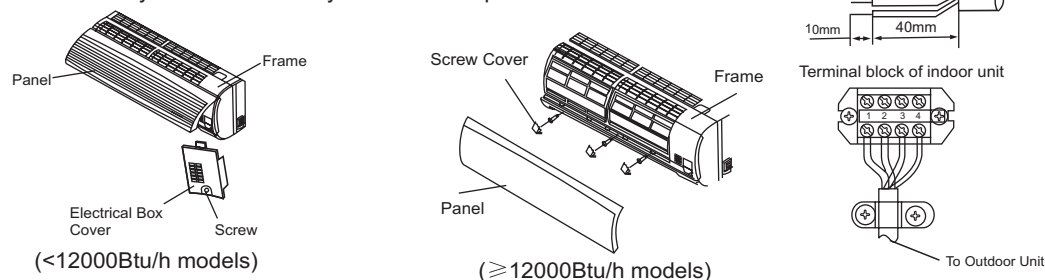

② OUTDOOR UNIT INSTALLATION

1. OUTDOOR INSTALLATION PRECAUTION

- Install the outdoor unit on a rigid base to prevent increasing noise level and vibration. Determine the air outlet direction where the discharged air is not blocked.
- In the case that the installation place is exposed to strong wind such as a seaside operation by putting the unit lengthwise along the wall or using a dust or shield plates.
- Specially in windy area, install the unit to prevent the admission of wind.
- If need suspending installation, the installation bracket should accord with technique requirement in the installation bracket diagram. The connection between bracket and wall, bracket and the air conditioner should be firm, stable and reliable.
- Be sure there is no obstacle which block radiating air.

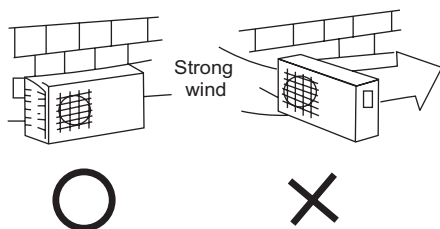

2. DRAIN ELBOW INSTALLATION

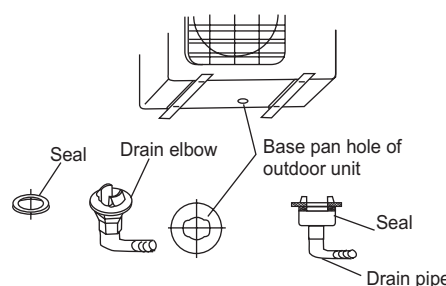

Fit the seal into the drain elbow, then insert the drain elbow into the base pan hole of outdoor unit, rotate 90° to securely assemble them. Connecting the drain elbow with an extension drain hose (Locally purchased), in case of the water draining off the outdoor unit during the heating mode.

3. REFRIGERANT PIPING CONNECTION

1. Flaring

1. Cut a pipe with a pipe cutter.

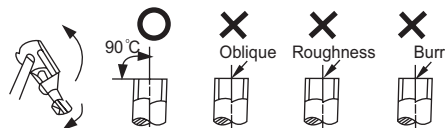

2. Insert a flare nut into a pipe and flare the pipe.

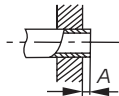

Outer diam. (mm)	A(mm)	
	Max.	Min.
φ 6.35	1.3	0.7
φ 9.53	1.6	1.0
φ 12.7	1.8	1.0

2. Tightening Connection

Align pipes to be connected.

- Sufficiently tighten the flare nut with fingers, and then tighten it with a spanner and torque wrench as shown.

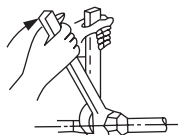

CAUTION

- Excessive torque can break nut depending on installation conditions.

Outer diam.	Tightening torque(N.cm)	Additional tightening torque(N.cm)
φ 6.35mm	1570 (160kgf.cm)	1960 (200kgf.cm)
φ 9.53mm	2940 (300kgf.cm)	3430 (350kgf.cm)
φ 12.7mm	4900 (500kgf.cm)	5390 (550kgf.cm)

4. WIRING CONNECTION

1. Remove the cover control from the unit by loosening the 3 screws.
2. Dismount caps on the conduit panel.
3. Temporarily mount the conduit tubes (not included) on the conduit panel.
4. Properly connect both the power supply and low voltage lines to the corresponding terminals on the terminal block.
5. Ground the unit in accordance with local codes.
6. Be sure to size each wire allowing several inches longer than the required length for wiring.
7. Use lock nuts to secure the conduit tubes.

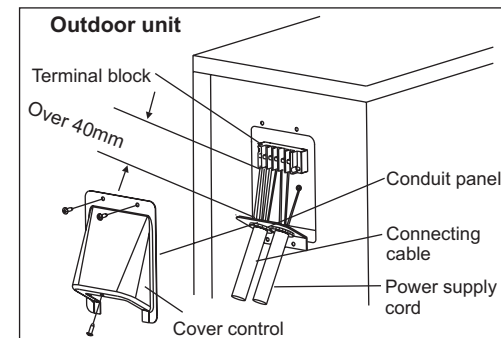

WARNING

- Be sure to comply with local codes while running the wire from the indoor unit to the outdoor unit.
- Every wire must be connected firmly.
- No wire should be allowed to touch refrigerant tubing, the compressor or any moving parts.
- Loose wiring may cause the terminal to overheat or result in unit malfunction.
- A fire hazard may also exit. Therefore, be sure all wiring is tightly connected.
- Disconnecting means must be provided and shall be located within sight from and readily accessible from the air conditioner.
- Connecting cable with conduit shall go through the hole of the conduit panel.

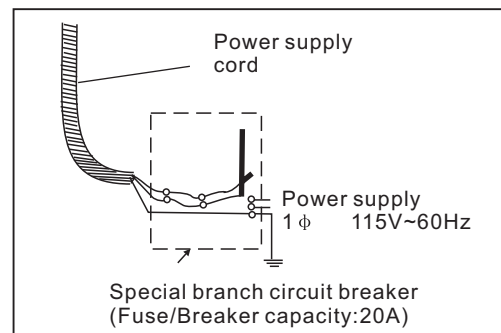

Note : To prevent wires loosening or leaving the Cord Clamp, please select proper cord diameter to fill the holes on the cord clamp.

③ AIR PURGE AND TEST OPERATION

1. AIR PURGE

Choose purge method from the table:

Connective pipe length	Air purging method	Additional amount of refrigerant to be charged
Less than 5m	Use vacuum pump.	—
5~10m	Use vacuum pump.	(Pipe length-5)x30g

- For the R407C/R410A refrigerant models, make sure the refrigerant added into air conditioner is liquid form in any cases.
- When relocate the unit to another place, perform evacuation, using vacuum pump.

CAUTION IN HANDLING THE PACKED VALVE

- Open the valve stem until it hits against the stopper. Do not try to open it further.
- Securely tighten the valve stem cap with a spanner or the like.
- Valve stem cap tightening torque.
Gas pipe side (φ 9.53): 2940N.cm (300kgf.cm)
Liquid pipe side (φ 6.35): 1570N.cm (160kgf.cm)

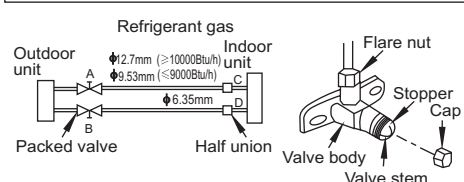

When Using the Vacuum Pump

(For method of using a manifold valve, refer to its operation manual.)

1. Completely tighten the flare nuts, A, B, C, D, connect the manifold valve charge hose to a charge port of the low-pressure valve on the gas pipe side.
2. Connect the charge hose connection to the vacuum pump.
3. Fully open the handle Lo of the manifold valve.
4. Operate the vacuum pump to evacuate. After starting evacuation, slightly loose the flare nut of the Lo valve on the gas pipe side and check that the air is entering. (Operation noise of the vacuum pump changes and a compound meter indicates 0 instead of minus)
5. After the evacuation is complete, fully close the handle Lo of the manifold valve and stop the operation of the vacuum pump.
- Make evacuation for 15 minutes and more and check that the compound meter indicates -76cmHg(-1.0x10⁵Pa).
6. Turn the stem of the packed valve B about 45° counterclockwise for 6~7 seconds after the gas coming out, then tighten the flare nut again. Make sure the pressure display in the pressure indicator is a little higher than the atmosphere pressure.
7. Remove the charge hose from the Low pressure charge hose.
8. Fully open the packed valve stems B and A.
9. Securely tighten the cap of the packed valve.

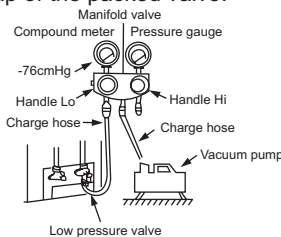

2. GAS LEAK CHECK

Make sure no gas come out from connections with leak detector or soap water.

CAUTION

A: Lo packed valve B: Hi packed valve
C and D are ends of indoor unit connection.

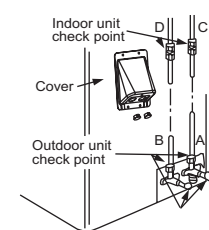

3. TEST OPERATION

Perform test operation after completing gas leak check at the flare nut connections and electrical safety check.

- Check that all tubing and wiring have been properly connected.
- Check that the gas and liquid side service valves are fully open.
- 1. Connect the power, press the ON/OFF button on the remote controller to turn the unit on.
- 2. Use the MODE button to select COOL, HEAT (cooling & heating modes only), AUTO and FAN to check if all the functions works well.
- 3. When the ambient temperature is too low (lower than 17°C), the unit can not be controlled by the remote controller to run at cooling mode, manual operation can be taken. Manual operation is used only when the remote controller is disable or maintenance necessary.
- Hold the panel sides and lift the panel up to an angle until it remains fixed with a clicking sound.
- Press the Manual control button to select the AUTO or COOL, the unit will operate under Forced AUTO or COOL mode (see User Manual for details).
- 4. The test operation should last about 30 minutes.